

Introduction

Tri-Tech Medical manifolds are cleaned, tested and prepared for the indicated gas service and are built in accordance with the Compressed Gas Association guidelines. The manifold consists of a regulator and a left and a right bank header. Pressure gauges show cylinder contents and delivery or line pressures. An optional pressure switch and optional remote alarm may be added to alert the need to replace depleted cylinders. Features of the manifold systems include a regulator, flexible pigtails with check valves and mounting hardware, online immediately available gas inventory.

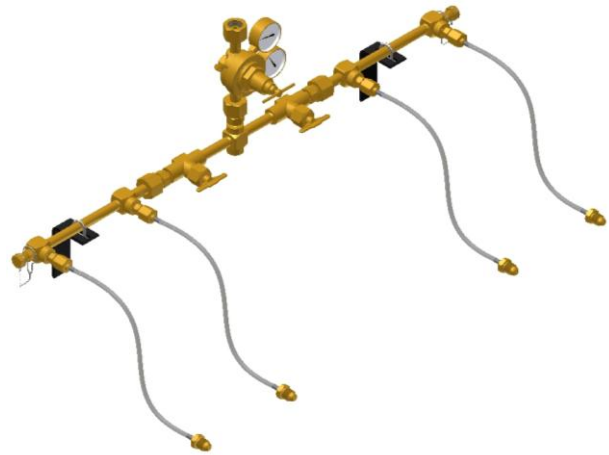

Model TMD-7-4B shown above

Warranty: All Tri-Tech Medical manifolds are warranted against defects in materials and workmanship for the period of one year from date of purchase.

Caution!

Failure to follow the following instructions can result in personal injury or property damage:

- Never permit oil, grease, or other combustible materials to come in contact with cylinders, manifold, and connections. Oil and grease may react with explosive force when ignited while in contact with some gases – particularly Oxygen and Nitrous Oxide.
- Cylinders, header and master valves should always be opened very **S-L-O-W-L-Y**. Heat of recompression may ignite combustible materials creating an explosive force.
- Pigtails should never be kinked, twisted or bent into a radius smaller than 3 inches. Mistreatment may cause the pigtail to burst.
- Do not apply heat. Oil and grease may react with explosive force when ignited while in contact with some gases – particularly Oxygen and Nitrous Oxide.
- Cylinders should always be secured with racks, chains, or straps. Unrestrained cylinders may fall over and damage or break off the cylinder valve which may propel the cylinder from its current position with great force.
- Oxygen manifolds and cylinders should be grounded. Static discharges and lighting may ignite materials in an oxygen atmosphere, creating an explosive force.
- Welding should not be performed near Nitrous Oxide piping. Excessive heat may cause the gas to dissociate, creating an explosive force.

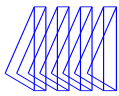

General Instructions

Manifolds should be installed in accordance with guidelines stated by the National Fire Protection Association, the Compressed Gas Association, OSHA, Canadian Standards Association, and all local codes. The Carbon Dioxide and Nitrous Oxide manifolds should not be placed in a location where the temperature will exceed 120°F (49°C) or fall below 20° F (-7°C). The manifolds for all other gases should not be placed in a location where the temperature will exceed 120°F (49°C) or fall below 0°F (-18°C). A manifold placed in an open location should be protected against weather conditions. During winter, protect the manifold from ice and snow. In summer, shade the manifold and cylinders from continuous exposure to direct rays of the sun.

Leave all protective covers in place until their removal is required for installation. This precaution will keep moisture and debris from the piping interior, avoiding operational problems.

CAUTION:

- Remove all protective caps prior to assembly. The protective cap may ignite due to heat of recompression in an oxygen system.

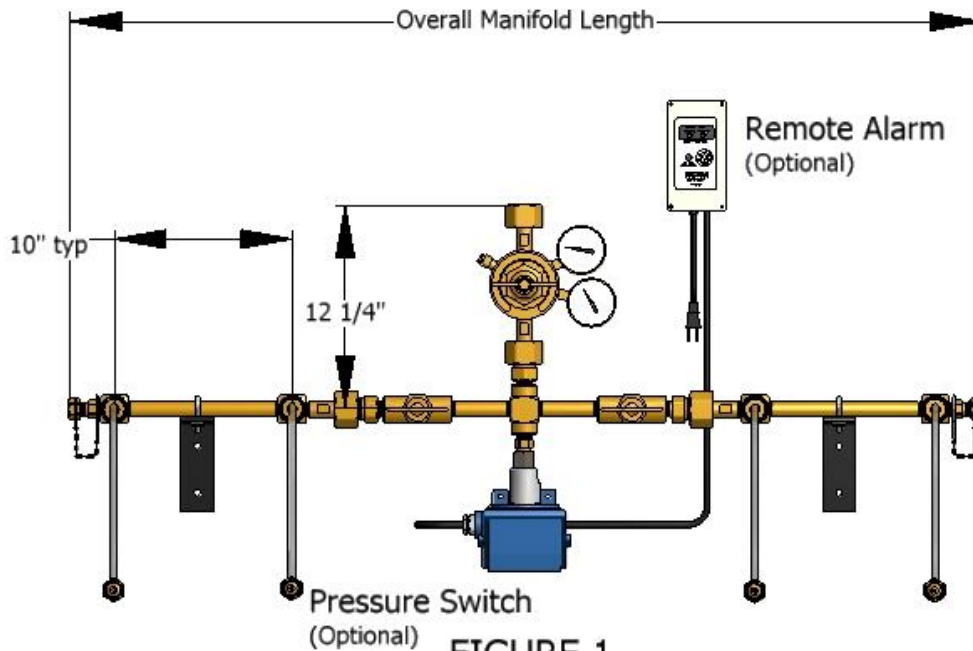
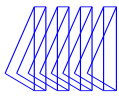

FIGURE 1

Total numbers of cylinders	2	4	6	8	10
Overall Manifold Length (using standard 10" center header configuration)	3'-4"	4'-8"	6'-4"	8'-0"	9'-8"
Overall Manifold Length (using staggered 5" center header configuration)	3'- 4"	3' - 10"	4' - 8"	5' - 6"	6' - 4"
Overall Manifold Length (using vertical crossover 10" center header configuration)	N/A	3' - 4"	N/A	4' - 8"	N/A

Note: Mark the manifold on the wall from the center of the header bar to the floor is **50"**



Optional Equipment/Features & Operation

Figure 1 depicts manifold part # TMDWP-540-4B. In this drawing the manifold center section has been built with a cross (instead of a tee) providing an extra port for installing an optional pressure switch (part # PS-160-3200) and an optional remote alarm (part # TAV-1) to be added. In this system, the remote audio visual alarm (part # TAV-1) will be triggered when the cylinder contents drops below the set point of the pressure switch, alerting that it is time to replace the depleted bank of cylinders and time to open the cylinder valves on the reserve bank of cylinders.

Figure 2 depicts manifold part # TMD-540-4B. In this drawing the manifold is designed to be used with one bank being placed in service by opening the cylinder valves and the master valve while the other bank is held in reserve by keeping the cylinder valves closed.

CAUTION:

- Master valves should remain open at all times. These valves are essentially emergency shut off valves and should only be used in to shut down a bank or both banks in the case of an emergency. The master valves should never be used to place a bank in service or reserve because these valves are not able to meter the flow of gas to the regulator and dangerous heat of recompression will occur. Possibly causing a fire.

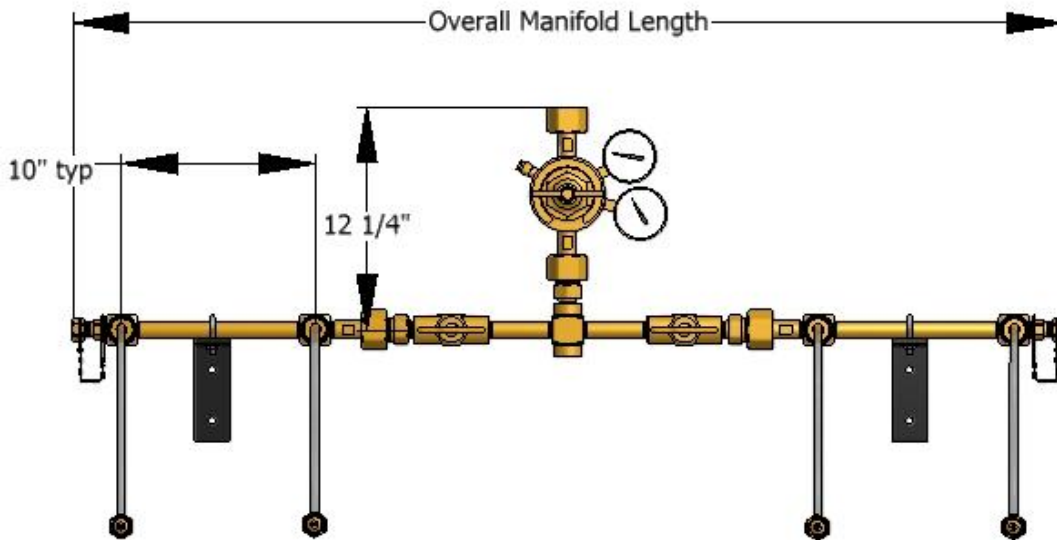
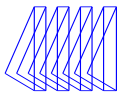

FIGURE 2

Total numbers of cylinders	2	4	6	8	10
Overall Manifold Length (using standard 10" center header configuration)	3'-4"	4'-8"	6'-4"	8'-0"	9'-8"
Overall Manifold Length (using staggered 5" center header configuration)	3'- 4"	3' - 10"	4' - 8"	5' - 6"	6' - 4"
Overall Manifold Length (using vertical crossover 10" center header configuration)	N/A	3' - 4"	N/A	4' - 8"	N/A

Note: Mark the manifold on the wall from the center of the header bar to the floor is **50"**



MANIFOLD ASSEMBLY

1. Assemble the regulator to the Control Section (Figure 3).
2. Assemble the headers to the Control Section inlets as shown in Figure 3.

NOTE:

- For long headers it may be easier to mount the headers before assembling to the Control Section.

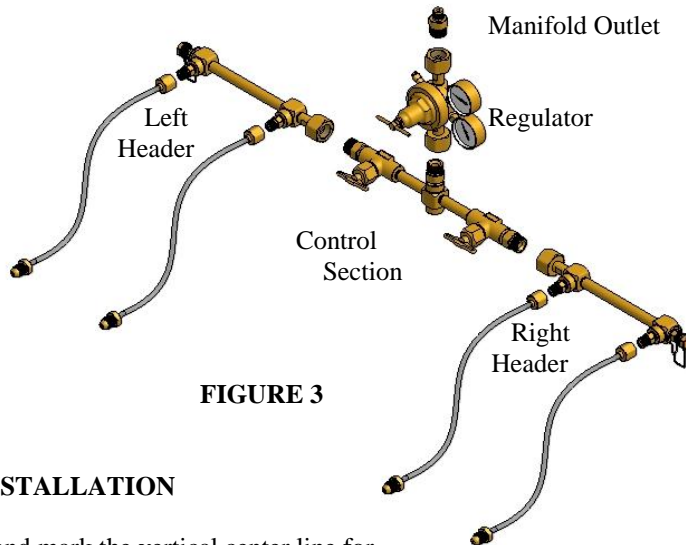

FIGURE 3

MANIFOLD INSTALLATION

1. Determine and mark the vertical center line for installation of the manifold (Figure 4).
2. Measure from the floor to a point 50" in height* of this vertical line. Using a level, mark a horizontal line at this point extending approximately 25" to the left and 25" to the right of center.

(*--Suggested manifold height. Wall mounting heights may vary from one installation to another depending on available space, cylinder height, etc.)

3. Remove the U-bolt assemblies from the mounting brackets. Position the bracket so that the top of the bracket is aligned with the horizontal line.
4. Mark a distance of 17" to the right and left of the center line. Mark the mounting holes and install brackets using fasteners suitable for the type of wall construction.

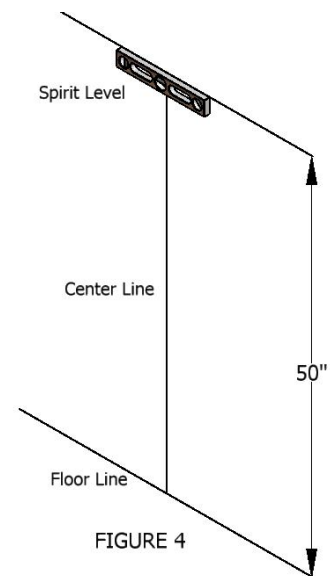
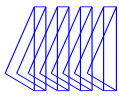

FIGURE 4

NOTE:

- Actual distance may vary, depending on configuration and the number of cylinders.

5. Mount the manifold by placing the header on the bracket. Fit the U-bolt over the header pipe and tighten the mounting nuts. (Figure 5)
6. Using a level, mark the placement of any additional mounting brackets while keeping the header on a horizontal plane. (Figure 5)



7. Remove the U-bolt assemblies from the header mounting brackets. Position the brackets so that the top of the bracket is aligned with the bottom of the headers. Brackets should be equally spaced to provide the most support and stability.
8. Mark the mounting hole and install fasteners suitable for type of wall construction. (Figure 5)
9. Fit the U-bolt over the piping and tighten the two mounting nuts.

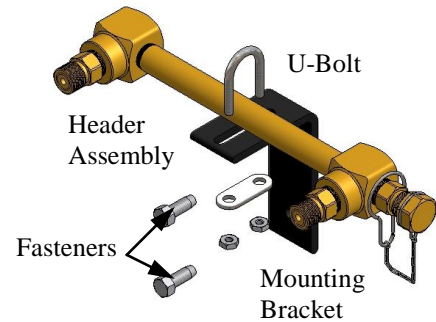

FIGURE 5

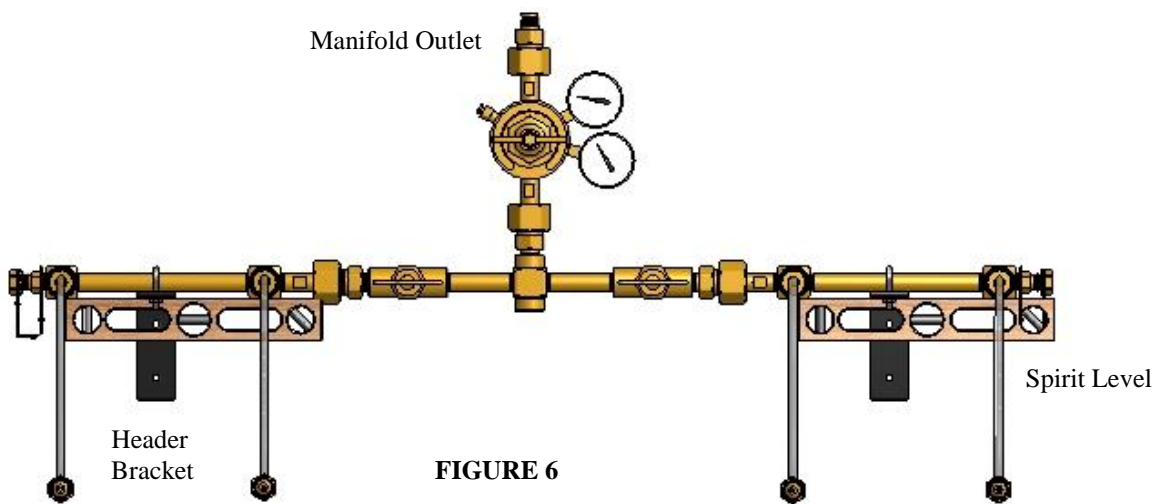

FIGURE 6

PLUMBING

1. A ½” NPT male union is supplied with the control and is located at the upper most part of the manifold control. Connect this union to the pipeline system. Sweat joints must be silver soldered. Use Bag-1 specification silver solder (DO NOT USE SOFT SOLDER). Heat the entire joint evenly. Apply enough heat favoring heavy sections, so that solder flows freely around the joint leaving no pin holes. The piping shall be purged during the brazing process. (Purging will prevent scale from forming on the inside of the Piping during the brazing process). The union provided permits removal of the manifold control for service. (Figure 7)
2. The piping for oxygen systems should be cleaned for oxygen service prior to connecting oxygen cylinders.
3. If the manifold is installed in a closed area, vent piping should be attached to relief valves.
4. Installation of a shut-off valve to isolate the pipeline during service to the manifold is recommended. (Figure 7)

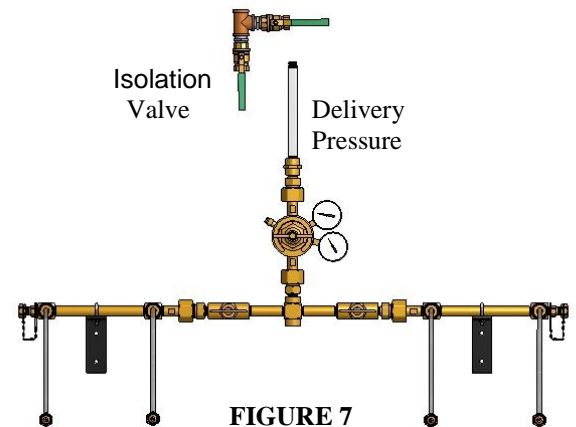
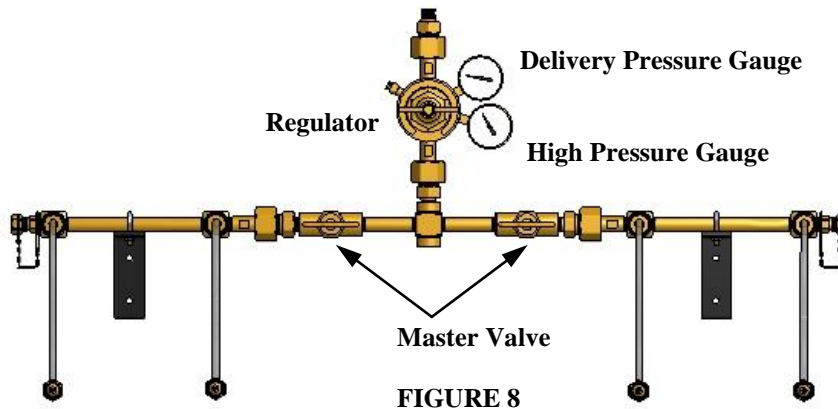
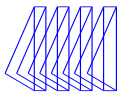

FIGURE 7



MANIFOLD OPERATION

The manifold control includes the following components and features; regulator, flexible stainless steel braided pigtailed with check valves, and headers designed to be easily expanded. The manifold is designed to use a line regulator (optional item) which can be mounted on the manifold outlet for delivery pressure less than 20 psig.

Gas flows through the header into the master shut off valve. The gas flows through the open valve to the regulator and then through the line regulator (if installed). Final delivery pressure is controlled by either the line regulator or by the manifold regulator should the application not require a line regulator. (A line regulator is not provided with the manifold.)

As cylinders deplete the high pressure gauge on the regulator along with any alarm systems installed will indicate that the bank of cylinders should be changed. Just before the supply bank goes empty the master valve on the reserve bank should be S-L-O-W-L-Y opened. This will ensure that the delivery of gas to the application is not interrupted.

After replacing empty cylinders, closed the master valve. This will hold your fresh cylinders in reserve until they are needed.

To insure proper operation, observe the following guidelines:

1. Carefully follow all instructions.
2. Establish proper flow direction of check valves.
3. Be sure the header master-shut-off valve is fully opened.
4. Be sure cylinder valves are fully opened.
5. Replace empty cylinders as soon as possible after the manifold has depleted.

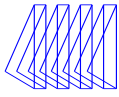

CYLINDER REPLACEMENT AND HANDLING

1. Shut off all cylinder valves and header valves as well as the master valve on the bank with the depleted cylinders.
2. **S-L-O-W-L-Y** loosen and remove the pigtail connection from the depleted cylinders.
3. Remove the depleted cylinders and replace the protective caps.
4. Remove the protective cylinder caps from the full replacement cylinders. With the valve outlet pointed away from you or anyone else, slowly open each cylinder valve slightly, in order to blow out any dirt or contaminants which may have become lodged into the cylinder valve.
5. Place and secure full cylinders into position using chains, belts, or cylinder stands.
6. Connect pigtails to cylinder valves and tighten with wrench.
7. **S-LO-W-L-Y** turn each cylinder valve until each cylinder is fully on.
8. The manifold supply bank is now replenished and is being held in reserve. This bank may be put in service by **S-L-O-W-L-Y** opening the master valve by following the instructions on page 6.

GENERAL MAINTENANCE

1. **Main Section**
 - a) Daily –record line pressure.
 - b) Monthly
 - 1a. Check regulators and valves for external leakage.
 - 1b. Check valves for closure ability.
 - c) Annually
 - 1a. check relief valve pressures.
 - 1b. check regulators for crawl (inability to maintain a set delivery pressure)
2. **Manifold Header**
 - a) Daily – observe nitrous oxide and carbon dioxide systems for cylinder frosting or surface condensation.
Should excessive condensation or frosting occur it may be necessary to increase manifold capacity.
3. **Monthly**
 - a) Inspect valves for proper closure.
 - b) Check cylinder pigtails for cleanliness, flexibility, wear, leakage, and thread damage. Replace damage pigtails immediately.
 - c) Inspect pigtail check valves for closure ability.
4. **Every 4 Years**
 - a) Replace all pigtails.